

**Rework Technic - EXPERT MiniOven-04 S/N**

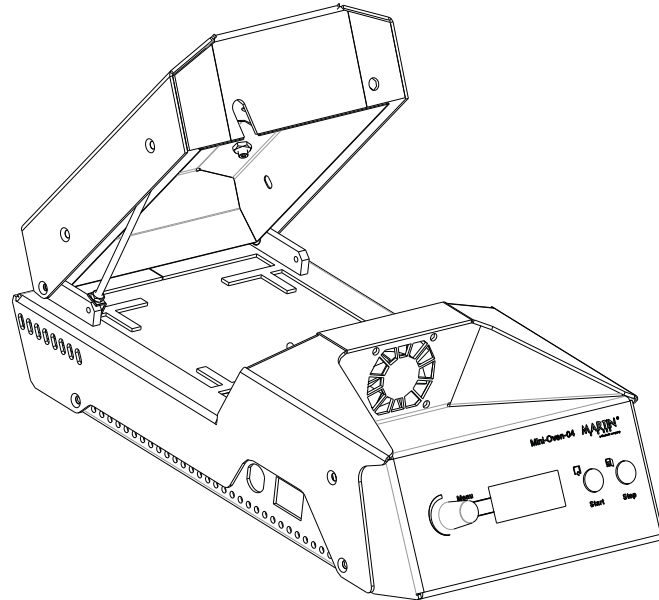

**HB00.0033 EXPERT MiniOven-04 S**  
Basic Unit for Reballing and QFN Prebumping  
incl. Toolset



HB00.0033

**HB00.0034 EXPERT MiniOven-04 N**  
Basic Unit f. Reballing and QFN Prebumping  
with process gas inlet incl. Toolset



HB00.0034

**Application Sets**

**LW50.9001 Reball 04 Set eco Standard**

LW40.0235 Reballing Fixture BGA 45\*45mm  
Standard



LW40.0235

LW40.0500 Reballing Frame Set BGA  
for all (98%) types of BGA, 7 pieces



LW40.0500

LW40.0543 Reballing-Mask BGA 45\*45mm  
n=1225 / Pitch=1,27 / Grid=35\*35 / Ball=0,762

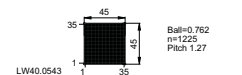

LW40.0543

LW40.0686 Reballing-Mask BGA 45\*45mm  
n=1156 / Pitch=1,27 / Grid=34\*34 / Ball=0,762

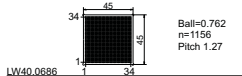

LW40.0686

LW40.0688 Reballing Mask BGA 45\*45mm  
n=1936 / pitch=1,00 / grid=44\*44 / ball=0,6

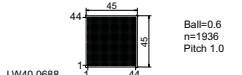

LW40.0688

LW40.0687 Reballing Mask BGA 45\*45mm  
n=1849 / pitch=1,00 / grid=43\*43 / ball=0,6

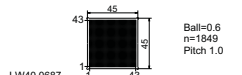

LW40.0687

**Rework Technic – EXPERT MiniOven-04 S/N**

**Application Sets**

**LW50.9002 Reball 04 Set PS 3 (RSX, CELL Version 1 + 2)**

LW40.0237 Reballing Fixture BGA 45\*45mm with 4 clips and support grid (to be used for PS3)

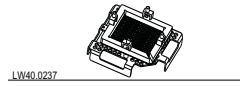

LW50.0599 Reballing Mask BGA 45\*45mm special n=1252 / pitch=1,00 / grid=41\*41 / ball=0,762

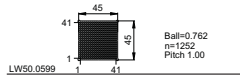

LW50.0601 Reballing Mask BGA 45\*45mm special n=1342 / pitch=1,00 / grid=41\*41 / ball=0,762

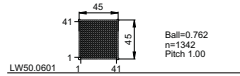

LW50.0596 Reballing Mask BGA 45\*45mm special n=1236 / pitch=1,00 / grid=41\*41 / ball=0,65

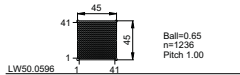

**SF29.0002 Prebump Set QFN**

HB50.0005 Tooling and Fixture for QFN Prebumping printer, holder, squeegee, tweezers

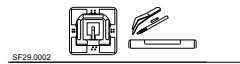

LW50.0204 Prebumping Mask + Frame QFN Type of Standard QFN Mask on request



**Options**

LW40.0235 Reballing Fixture BGA 45\*45mm Standard



LW40.0236 Reballing Fixture BGA 45\*45mm 4 Downholder Clips



LW40.0237 Reballing Fixture BGA 45\*45mm with 4 clips and support grid (to be used for PS3)



**Consumables**

VD90.5105 Solder Balls, 50,000 pcs., lead free CSP Sn96,5Ag3Cu0,5 300µm (=5,2g)

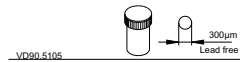

VD90.5101 Solder Balls, 50,000 pcs., lead free BGA Sn96,5Ag3Cu0,5 762µm (=86g)

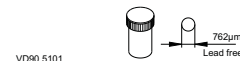

VD90.0230 Solder Paste print 5ccm finepitch 4 lead free Sn96,5Ag3Cu, ROL0, 20-38µm

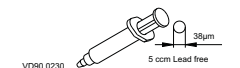

HT00.0119 Flux Creme lead free 18g 0506 MA, no clean, RELO, with brush



HT00.0009 Flux Pen lead free 0405 C, no clean, RELO

