

DOTLINER 07.6

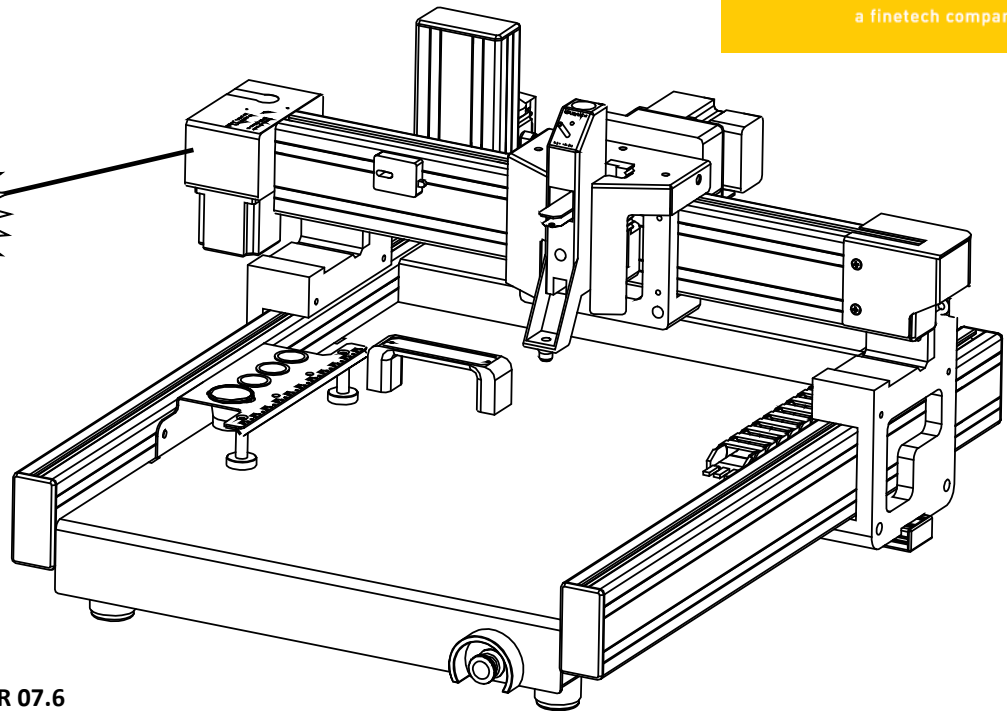

PD00.0071 DOTLINER 07.6

In DOTLINER dispensing robots the PCB is not moving but fixed in place. This eases loading and unloading of PCBs. MARTINs flexible PCB holders and PCB support tools allow the secure and stable installation of the substrates.

DOTLINER machines apply the well-proven ATP dispensing technology and are best prepared for micro dispensing applications. That involves dispensing of liquid materials like i.e. oil as well as high viscose products such as solder paste or grease.

A wide range of selections allow for instance heating of the dispense nozzle, cooling of cartridge, or the measuring of dispense height with touch-down sensor. All options can be used and configured through the newest version of PC software EASY DISPENSE Pro. A color CCD camera with Auto-Zoom function is available to measure-in the sample position.

MARTINs low stress dispense nozzles provide best material delivery conditions and are available with various nozzle diameter. Mechanical adapter take care to match even standard dispense needles with the heated MARTIN nozzle receptacle. The standard interface at DOTLINER dispense head enable quick change of the dispense heads.

Standard Equipment

- Control unit with 5ccm dispensing head
- Motorized XYZ gantry system (stepper motor)
- Colour-zoom-camera
- 4x PCB magnet holders 40.5mm (standard)
- PCB support rail DL-type
- Test point and standby platform
- Manual

Technical Data

Max. PCB size:	500 x 400 mm ²
Travel:	495 x 325 mm
Travel-Speed:	1 – 9000 mm/min
Resolution of Axes:	0.013 mm
Dot Volume:	0.0005 – 5.0 mm ³
Dot Diameter:	≥ 0,1 mm
Line Pressure:	0.1 – 5.0 bar
Syringe Heating:	20 - 50 °C
Temperature Compensation:	0 - 50 °C
Full level Compensation:	self learning
Mains:	230 VAC / 140 VA
Pressurized Air:	5.5 - 8 bar / water and oil free
Footprint:	700 x 600 mm ²











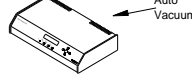
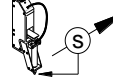
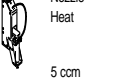
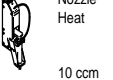

Options

Vacuum Retract -20 mbar – 0 mbar (Fill Level Detection)

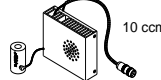
Cartridge Cooling: -10K room temperature

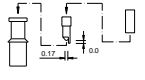
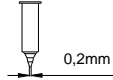
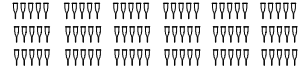
DOTLINER 07.6

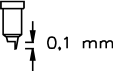
Optional Extras

PD50.0002	Starter Kit Dot Liner for solder paste applications	
PD50.0003	Starter Kit Dot Liner for adhesive applications	
CD00.0110	Auto vacuum module for thin fluids	
DK00.0030	Hight sensor for dispensing head dispensing w/o spacer, incl. spacer "0.0"	
DK00.0052	Dispensing head 5ccm with heating, for CD04/05	
DK00.0053	Dispensing head 10ccm with heating, for CD04/05	
DK00.0054	Dispensing head 30ccm with heating, for CD04/05	
DK00.0056	Dispensing head 55ccm with heating, for CD04/05	
DK02.0002	Cooling Module 5ccm for DL / CD, 10 °C cooling power	
DK02.0003	Cooling Module 10ccm for DL / CD, 10 °C cooling power	
HT00.8009	Micro Disp. Nozzle 0.17mm / 0.08 for paste 6, pitch 0.4 - 0.8 mm	
HT00.8004	Micro disp. nozzle 0.17mm / 0.0 HS for paste 6, pitch 0.4 - 0.8 mm	
HT00.8010	Metal Dispensing Nozzle 0.2mm AH for paste 5, Pitch 0.5 - 1.0	
VD90.0039	Dispensing Needles/Nozzles set 10 pieces each 18 types, box	
HT00.9009	Spacer "0.0" for metal nozzles (from 0.16mm)	
HT00.9010	Spacer 0.10 mm for nozzle 0.2 mm	
HT00.9023	Spacer Pliers Lines Type A for needles 1.6 - 2.2mm, 1 ring	
HV00.0013	Cam Designer professional for Dot Liner, DVD, manual	
HT00.0002	Adhesive Volume Meter KVM-03 measuring range 0.01-3,0 ccm	